

Documentation

C.P.S. Power unit

Range

12V / 10A

12V / 16A

12V / 25A

S.A.S CRISTEC

31, rue Marcel Paul - Z.I. Kerdroniou Est

29000 QUIMPER

FRANCE

Tél : 33 (0)2.98.53.80.82

Fax : 33 (0)2.98.55.64.94

e-mail : info@cristec.fr

<http://www.cristec.fr>



Operating Manual in English

Page 3

WARRANTY CARD

Page 22

Do not forget to fill in the warranty card and send it back to us.



CONTENTS

DESCRIPTION	PAGE
Contents	3
① Introduction	4
1.1 Installation and operating manual	4
1.2 Validity of this document	4
1.3 Guarantee	4
1.4 Brief presentation	4
Installation and connection diagram	5
1.5 Reference standards applied	6
② Characteristics and operation	7
2.1 Technical characteristics	7
2.2 Charger operation	10
③ Installation	12
3.1 Introduction	12
3.2 Items supplied	12
3.3 Additional supplies necessary for electrical installation	12
3.4 Special recommendations for installation	14
3.5 Commissioning	16
④ Maintenance and repair of equipment	17
4.1 Introduction	17
4.2 Equipment maintenance	17
4.3 Equipment repair	17
⑤ Safety	18
5.1 Standards references	18
5.2 Precautions relating to personnel safety	18
5.3 Precautions relating to protection against fire and explosion	18
⑥ Appendice	19



① Introduction

1.1 Installation and operating manual

The present document applies to power unit in the CRISTEC CPS range of power units listed below.

Power (Watts)	U/I Rating	CRISTEC Reference
120	12/10	SEEL006685
190	12/16	SEEL006686
300	12/25	SEEL006687

This manual is intended for users, installers and equipment maintenance personnel who must ensure they understand the present document before any intervention on the power unit.

1.2 Validity of this document

This document is the property of CRISTEC; all the information contained in this document applies to the accompanying product. The company reserves the right to modify the specifications without prior notice.

1.3 Guarantee

Failure to comply with the rules for installation and operation cancels the manufacturer's guarantee and absolves CRISTEC of all responsibility.

The period of guarantee is 36 months. It applies to parts and labour for an **equipment returned to the factory**. Only parts acknowledged to have been defective from the outset will be replaced under the guarantee.

Equipment which has been misused or damaged by errors in connections, impacts, falls or which is defective from having been worked upon by persons other than those authorized by CRISTEC Industries.

Equipment which has been installed or operated at variance with procedures outlined in the manual provided with each unit.

Under no circumstances, can any indemnity be granted by this warranty.

This warranty does not apply to the following terms :

① Transportation and packaging charges to and from the factory or authorized service station.

② Damage sustained in shipment, apparent or concealed.

Claims for such damage must be reported and filed with the carrier by the person receiving the equipment.



1.4 Brief presentation

Designed in partnership with the main French boat builders, the CRISTEC power units allow to get in a single cabinet the on-board 230VAC protection and a battery charger.

The power housings meet the European on-going rules. Compact and lightweight, they provide practical entry for the cabling that reduces mounting time.

The 230VAC user protection is insured by a 16A/30mA differential circuit breaker. The 230VAC on-board utilisation outputs are protected by 2 off 10 DPN thermo-magnetic circuit breakers.

The charger function is made by a switch mode charger PCB from our classic CPS charger range : **Selective Programmable Charge**.

General characteristics :

- Input voltage : 115 or 230VAC +/-15%
- Input frequency : from 47 to 63 Hz
- Display : green LED for mains present
- Input and output cabling on gland
- Functioning temperature : 0°C/+40°C
- Matt black RAL 9011 and grey RAL 7035, salt atmosphere resistant
- CE standards: EN50081-1, EN50082-1, EN 55011, EN55022, EN60950 & ISO 13297

Charger characteristics :

- Input voltage : 115 or 230VAC +/-15% by internal switch
- Output voltage : 12VDC +/-1%
- Three automatic charge cycles : boost, absorption, floating
- Six hours programmable timed boost by internal switch
 - Position "**BOOST ON**" for authorize boost
 - Position "**BOOST OFF**" for inhibit boost
- Charge distributor incorporated into each battery output
- Specific output matched to the engine battery charging on 16A and 25A models
- Selection of the level of charge according to the type of battery by internal switch
 - Plomb/Antimoine (**ANT**)
 - Plomb/Calcium (**CAL**)
- Internal potentiometer allows output voltage to be adjusted
- Protection against shorts-circuits and polarity reversal. Fuses on input and output.
- Low noise, thermostatically controlled electric fan on 25A model



Characteristics distribution AC :

- General input protection by a 30mA / 16A differential circuit breaker.
- AC outputs : protected by 2 thermo-magnetic circuit breaker DPN 10A.
- ⇒ When they leave the factory the chargers are configured as follows :
 - Mains supply: 230 Vac
 - Battery: Lead/Antimony
 - Charging mode : Boost then automatic switch to Floating
 - Output voltage setting in Floating:
 - ◆ at 13.8 V \pm 1% off load
- ⇒ Cable entry is via cable glands.
- ⇒ Dimensions drawing : see appendice.
- ⇒ Terminal drawing : see appendice.
- ⇒ Fixing drawing : see appendice.
- ⇒ Setting charger board drawing : see appendice.

1.5 Reference standards applied

The standards applied are:

- **NF EN 60950 + A1 + A2** (October 93): safety of information processing equipment including electrical office equipment.
- **NF EN 50081-1** (June 92) EMC: Generic standard for emissions
- **NF EN 50082-1** (June 92) EMC: Generic standard for immunity
- **NF EN 55022** (December 1994): Limits and methods for measuring the characteristics of RF interference produced by information processing equipment.

Enacted at Quimper on: 2 March 2000

For and on behalf of CRISTEC SA,



② Characteristics and operation

2.1 Technical characteristics

2.1.1 Mechanical characteristics

All models have an IP 21 protection rating. They are made of steel or of aluminium. These parts are protected by several coats of epoxy paint.

Overall dimensions and weights of the various models are specified in the table below :

Model	Length (mm)	Height (mm)	Depth (mm)	Weight (kg)
12V / 10A	290	220	75	3.2
12V / 16A	345	220	110	4.4
12V / 25A	345	220	110	4.4

Dimensions and fixing drawing : see appendice.

2.1.2 Input characteristics of charger

Model	Permissible input voltage (Vac)	Permissible input frequency (Hz)	Typical input current rating at 115 Vac	Typical input current rating at 230 Vac	Fuse rating and format
12V / 10A	115 Vac +/- 15% or 230 Vac +/- 15% single phase by manual selection	47 to 63 Hz	3A	1.5A	3.15A T 5 x 20
12V / 16A			4A	2A	10 A T 6.3 x 32
12V / 25A			6A	3.3A	10 A T 6.3 x 32

2.1.3 Output characteristics of charger

2.1.3.1 Output voltage of charger

The output voltages shown in the table below are obtained at 10% of rated power on outputs BAT 1 and BAT 2. For those models having a BAT D output, the voltage level is reduced by about 0.4 V.



These values are set in the factory with an accuracy of $\pm 1\%$ and can be adjusted by turning the potentiometer POT U (use a suitable tool for turning the potentiometer screw).

They depend on the type of battery and mode of operation selected.

Model	Lead/Antimony Battery "Floating" Mode	Lead/Antimony Battery "Boost" Mode	Lead/Calcium Battery "Floating" Mode	Lead/Calcium Battery "Boost" Mode
12V / 10A	13.8 Vdc	14.5 Vdc	14.6 Vdc	15,4 Vdc
12V / 16A				
12V / 25A				

2.1.3.2 Output current of charger

The table below defines the maximum output current at rated output power as well as the type and rating of the fuses placed in series with the charger outputs.

Model	Maximum output current	Fuse rating	Type of fuse
12V / 10A	10 A	15 A	257015 LITTLEFUSE
12V / 16A	16 A	20 A	257020 LITTLEFUSE
12V / 25A	25 A	25 A	257025 LITTLEFUSE

2.1.4 Environmental specification

All chargers in the range meet the following characteristics:

- Storage temperature: - 20°C to + 70°C.
- Operating temperature: 0°C to + 40°C.
- Humidity: < 90% non-condensing

2.1.5 Protection and operating safety of charger

2.1.5.1 Input protection

Models 12V / 10A, 12V / 16A, 12V / 25A are fitted with two pole protection by 2 fuses F1 and F2 whose ratings are given in section 2.1.2.

2.1.5.2 Output protection

Output protection is provided by a fuse placed in series with the "-" terminal of the charger. The rating and type of this fuse are defined in the table in section 2.1.3.2.



2.1.5.3 Additional safety devices

All models are fitted with the following safety devices:

- Protection against input voltage surges by a Varistor (275 Vac).
- Protection against abnormal heating of the power semiconductors.
- Protection against polarity reversal (output fuse blows)
- Protection against overloads on the output by limiting the power to the rated value for each model.

2.1.6 Options

The options do not form part of the basic power unit supply. They are available from your reseller or from CRISTEC's Sales Department.

- **Analogue voltmeter for displaying the charging voltage at the input side of the charge distribution diodes.**

Model	Rated output voltage (V)	Voltmeter reference
Charger 12V	12 V	VLT 0012

- **Analogue ammeter for displaying the total battery charging current**

Model	Maximum output current	Ammeter reference
12V / 10A	10 A	AMP 0120/1
12V / 16A	16 A	AMP 0190/1
12V / 25A	25 A	AMP 0300/1

- **Battery temperature compensation***

Probe length	Probe reference
1 m	STEMP/1
3 m	STEMP/3

* : Except for models 12V / 10A.

2.2 Charger operation

2.2.1. Output voltage

The charger delivers a voltage suitable for recharging 1, 2 or 3 separate batteries.

All models (12V / 10A) are fitted with an output suitable for recharging the engine battery (BAT D output). Nevertheless, for chargers 12V / 10A, you can use one of the outputs for recharging engine battery.

2.2.2. Block diagram of charger

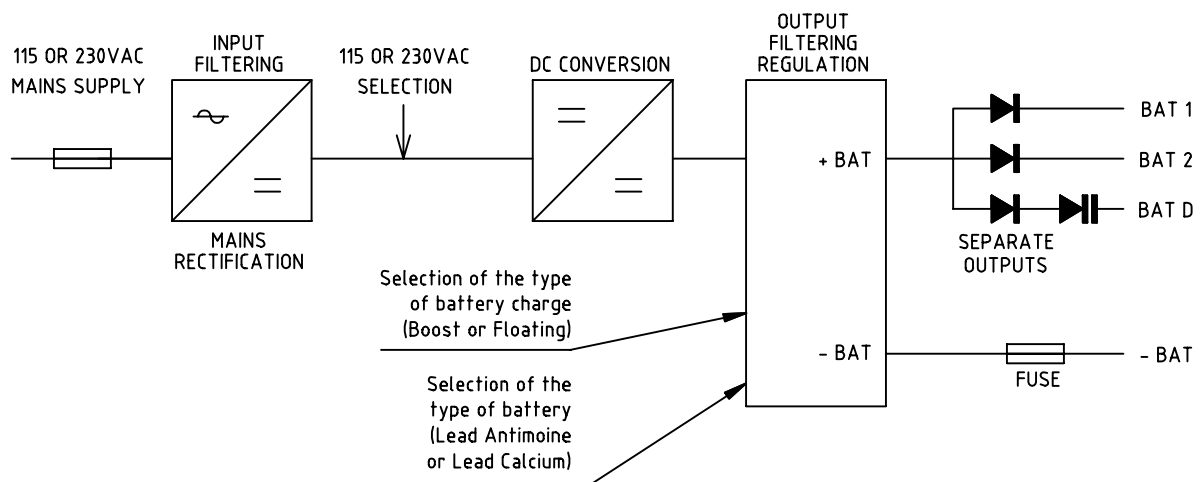

2.2.3. Principle of operation

The CPS range of battery chargers are designed on the basis of a high frequency switching converter which transforms the ac signal into a regulated, filtered dc voltage suitable for charging accumulator batteries.

2.2.4. Detailed operation

After the initial selection of input mains, type of battery and type of charge, battery charger operation is entirely automatic.

2.2.4.1 Selector operation

● Mains voltage selector

The charger is fitted with an internal voltage selector enabling it to operate on 2 types of mains supply :

- European mains supply: 230 Vac – 50/60 Hz
- Other mains supplies (USA, etc. ...): 115 Vac – 50/60 Hz



● Battery type selector

The charger is fitted with an internal selector enabling it to operate on 2 types of battery just by changing a switch:

- Lead/Antimony battery: "**ANT**"
- Lead/Calcium battery: "**CAL**"

● Charge type selector

The charger is fitted with an internal selector enabling it to provide 2 types of charging just by changing a switch:

- Charge in Floating mode: "**BOOST OFF**"
- Charge in Boost mode for 6 hours \pm 30 minutes then automatic switch to Floating mode: "**BOOST ON**"

NB: The Boost voltage off load is about 5% higher than the off load Floating mode voltage.

2.2.4.2 Operation of the indicators

This indicator is fitted on the charger front panel and displays the unit's mode of functioning. Differential circuit breaker ON.

● "Mains present" indicator

This indicator is extinguished in the following circumstances:

- Absence or degradation of the ac mains supply,
- Differential circuit breaker OFF or triped.

2.2.4.3 Special operation

● Special batteries

The factory settings are for standard use of Lead/Antimony and Lead/Calcium batteries. Refer to a professional installer for special settings to match the battery manufacturer's specifications, taking into account the special features of the installation.



● Electricity generating sets

The CRISTEC battery charger is designed for use from an electricity generating set.

In certain circumstances, electricity generating sets can generate large overvoltages. Before connecting the charger, check that the charger is compatible with the generator: power, voltage, voltage surges, frequency, current, ...

③ Installation

3.1 Introduction

This section deals with matters relating to charger installation.

Installation and operating the charger for the first time must be undertaken by an electrician or professional installer in accordance with the standards in force (in the case of pleasure boats, comply with the international standard ISO 13297).

The installer must take note of this operating manual and must inform users of the matters relating to installation and safety contained in section 5.

3.2 Items supplied

CRISTEC supply items include the following elements:

- 1 metal case containing the battery charger electronic functions and circuit breaker
- the present documentation (operating manual).

3.3 Additional supplies necessary for electrical installation

These items do not form part of CRISTEC's supply.

References to additional supply items which are necessary for correct operation of the charger are defined in the following sections:

Any failure to comply with these provisions will result in cancellation of the manufacturer's guarantee.

**3.3.1. Cable connecting to the public mains supply or to an electricity generating set**

Depending on line lengths, cables connecting to the ac mains supply MUST have a cross-section equal to, or greater than, the values shown in the table below:

Model	Minimum cross-section and types of cable for 115 Vac	Minimum cross-section and types of cable for 230 Vac
12V / 10A	3 x 1.5 mm ² HO7-VK	3 x 1.5 mm ² HO7-VK
12V / 16A		
12V / 25A		

It is ESSENTIAL to use endfittings with insulated sleeves (in accordance with standard NF G 63-023) for connecting the mains input.

The PE conductor (commonly called "earth" green/yellow wire) of the AC source MUST be connected to the power unit on the terminal provided for this purpose.

3.3.2. Battery connection cable

Depending on line lengths, cables connecting to the batteries MUST have a cross-section equal to, or greater than, the values shown in the table below:

Model	Cross-section and type of battery connection cables	Type of terminal Cross-section of cable and diameter of the terminal hole
12V / 10A	4 mm ² HO7-VK	4 mm ² - 6 mm
12V / 16A	6 mm ² HO7-VK	6 mm ² - 5 mm
12V / 25A	10 mm ² HO7-VK	10 mm ² - 5 mm

It is ESSENTIAL to use the cable glands on the underside of the case in order to prevent any damage to the cables on the metal edges of the case and to guarantee double insulation between the live conductors and electrical earth.

3.3.3. Voltmeter and Ammeter link cable (only on certain models)

These cables must have a cross-section equal to, or greater than, 0.34 mm² and be of type: KZ0506 - 600 V.

They must have endfittings with insulating sleeves in accordance with NF G 63-023.

It is ESSENTIAL to use the cable glands on the underside of the case in order to prevent any damage to the cables on the metal edges of the case and to guarantee double insulation between the charging circuit and electrical earth.



3.3.4. Installation earthing cable

The cable linking the installation to earth MUST be connected to the earth screw situated inside the power unit.

The cable used must have a minimum cross-section of 2.5 mm², be of the type HO7-VK and be fitted with a suitable terminal.

3.4 Special recommendations for installation

3.4.1. Case position

3.4.1.1. Preventing the charger overheating

The charger is designed to be mounted on a vertical wall as shown on appendice drawing.

An area of 150 mm from the sides, top and bottom of the case should be kept clear.

Cooling is provided by forced ventilation on certain models. The installer must make the necessary arrangements to ensure that the temperature of the air at entry is less than 40°C in extreme operating conditions.

Arrangements must also be made to ensure hot air can get away either side of the power unit.

3.4.1.2 Preventing running water or spray falling on the power unit

The protection factor is IP21 and the power unit position must be chosen so as to prevent any moisture or salt entering the power unit.

If this were to occur, the equipment would be irreversibly damaged and there would be a potential risk to the user.

You are recommended to position the power unit in a dry, well-ventilated location, away from any source of heat.

3.4.1.3 Arrangements for the batteries

Batteries connected to the charger are likely to give off explosive gases during the charging phase.

You are therefore recommended:

- to ban the use of any equipment generating sparks and flames near to the batteries.
- to position the batteries in a well-aired and ventilated location.
- to take note of the battery manufacturer's instructions when installing the batteries.



3.4.1.4 Accidental leakage currents to earth

① Accidental leakage current between line and earth

Comply with standard NFC 15-100 in respect of precautions over installation. Have the connection work done by an electrician or professional installer.

② Accidental leakage current between charge circuit and earth

Detection of accidental leakage currents to earth must be provided by a safety device outside the power unit (residual differential current device or insulation monitor device).

The installer must ensure that the rating and nature of the protection are appropriate for the risks.

Special precautions are recommended on any installation where there is a danger of electrolytic effects.

Regulations require the presence of a battery cut-out on the output + pole and on the output - pole.

3.4.1.5 Precautions regarding lightning strike

In geographic zones exposed to a high risk of lightning strikes, it may be worthwhile fitting a lightning conductor on the inlet side of the power unit in order to prevent the latter being irreversibly damaged.

3.4.1.6 Electromagnetic interference generated by the power unit

- Use screened cable for all connections (*). The screening at both the emitter end and receiver end must be connected to earth.
- Make sure the length of the cables and screening connections are kept as short as possible.
- Route the cables as close to earthed objects as possible ("flying" cables or cable loops are to be avoided – fasten the cables against earthed objects).
- Separate the power supply cables from output cables.
- Separate power cables from monitor signal cables (minimum 200 mm).
- Cables must carry only the power unit power supply. Branch or bridging connections in order to supply another equipment are to be banned.

(*) This is advice for installation and not an obligation. The electrician installer will decide whether to use screened cable or not, based on the EMC environment.



3.5 Commissioning

This section lists the operations to be performed in order to commission the power unit. It is advisable to comply strictly with these instructions before switching on for the first time.

3.5.1. Selecting the mains supply voltage

Selection of the input mains supply is made using the selector inside the metal case.

Precautions to be taken in using this selector are as follows:

- There must be no ac voltage present when the selector is moved.
- Position the voltage selector as a function of the type of alternating mains supply used.

If this selector is incorrectly set irreversible damage to the power unit may occur.

3.5.2. Selecting battery type

Drawings in appendice show the position of the selector as a function of the type of battery used.

Precautions to be taken in using this selector are as follows:

- You **MUST** check the compatibility of the selection and the type of battery connected **BEFORE** you switch on.

3.5.3. Selecting charge mode

Drawings in appendice show the position of the selector as a function of the type of charge used.

Precautions to be taken in using this selector are as follows:

- You **MUST** check the compatibility of the "**BOOST ON**" mode voltage with the type of battery connected.
- During the winter period, or periods of prolonged power unit connection to the batteries, if the charger remains switched on set the switch to "**BOOST OFF**" as a matter of course.
- If using the "**BOOST ON**" function, the starter motor battery **MUST** be connected to BAT D on models having 3 outputs.
- If the charger is supplying 1, 2 or 3 banks of batteries with a low rate of discharge, you are advised to select the "**BOOST OFF**" mode.
- If there is instability on the alternating mains supply to the charger (micro-breaks > 500 ms), the charger will re-initialise the Boost period of 6 hours ± 30 minutes and, in time, result in battery deterioration. In such circumstances, we recommend that you select the "**BOOST OFF**" mode.



3.5.4. Verifying the charge voltage

Before connecting batteries to the charger, you **MUST** check battery polarity.

Check also the voltage of the batteries using a calibrated voltmeter. Too low a voltage on certain types of battery can indicate irreversible damage and an inability to take a recharge.

3.5.5. Connecting up the options

You **MUST** contact your reseller or CRISTEC's Sales Department.

④ Maintenance and repair of the equipment

4.1 Introduction

This section deals with arrangements for maintenance and repair of the equipment. Correct operation and the life of the product are conditional on strictly complying with the recommendations below.

4.2 Equipment maintenance

- Disconnect the power unit from the alternating mains supply for all maintenance operations.
- If the power unit is placed in a dusty environment, vacuum it periodically to clean it since layers of dust might affect heat dissipation.
- Check the state of charge of the batteries every three months.
- An annual check that nuts and bolts are tight is necessary in order to guarantee correct functioning of the power unit (especially in an environment subject to vibration, shock, large changes in temperature, etc.).
- A complete technical examination by a CRISTEC recommended serviceman is advisable every 5 years. This general technical examination can also be carried out in our factories.

4.3 Equipment repair

- Disconnect the power unit from the AC mains supply and from the batteries before carrying out any repairs.
- If a fuse has blown, make sure the replacement complies with the rating and type of fuse recommended in section 2.1.
- For any other repair action, contact a reseller or CRISTEC.



⑤ Safety

5.1 Standards references

- Class I equipment in accordance with standard NF EN 60950.
- Installation requirements are contained in standard NFC 15-100 and the specific standard for "pleasure boats– electrical systems – Installation of ac distribution system", reference ISO 13297.

5.2 Precautions relating to personnel safety

- Installation must be undertaken by an electrician or professional installer.
- The alternating mains supply must be cut off before any intervention on the equipment.

5.3 Precautions relating to protection against fire and explosion

- Use the fuses defined in section 3.1.
- In the vicinity of the batteries:
 - Ventilate the room,
 - Do not smoke,
 - Do not use a naked flame.

**APPENDICE**

Dimensions POWER UNIT 12V/10A	06688 07
Dimensions POWER UNIT 12V/16A	06689 07
Dimensions POWER UNIT 12V/25A	06690 07
Connecting fixing POWER UNIT 12V/10A	06688 08
Connecting fixing POWER UNIT 12V/16A	06689 08
Connecting fixing POWER UNIT 12V/25A	06690 08
Setting charger board 12V/10A	05381 04
Setting charger board 12V/16A	05383 03
Setting charger board 12V/25A	05386 03

288

unité d'énergie

power unit

ON

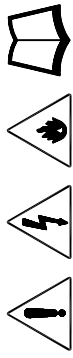
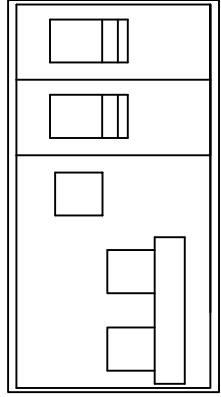

CE 115 / 230VAC 50 / 60HZ

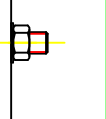
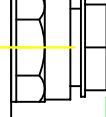
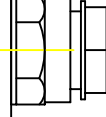
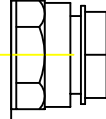
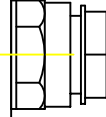

202

225

63

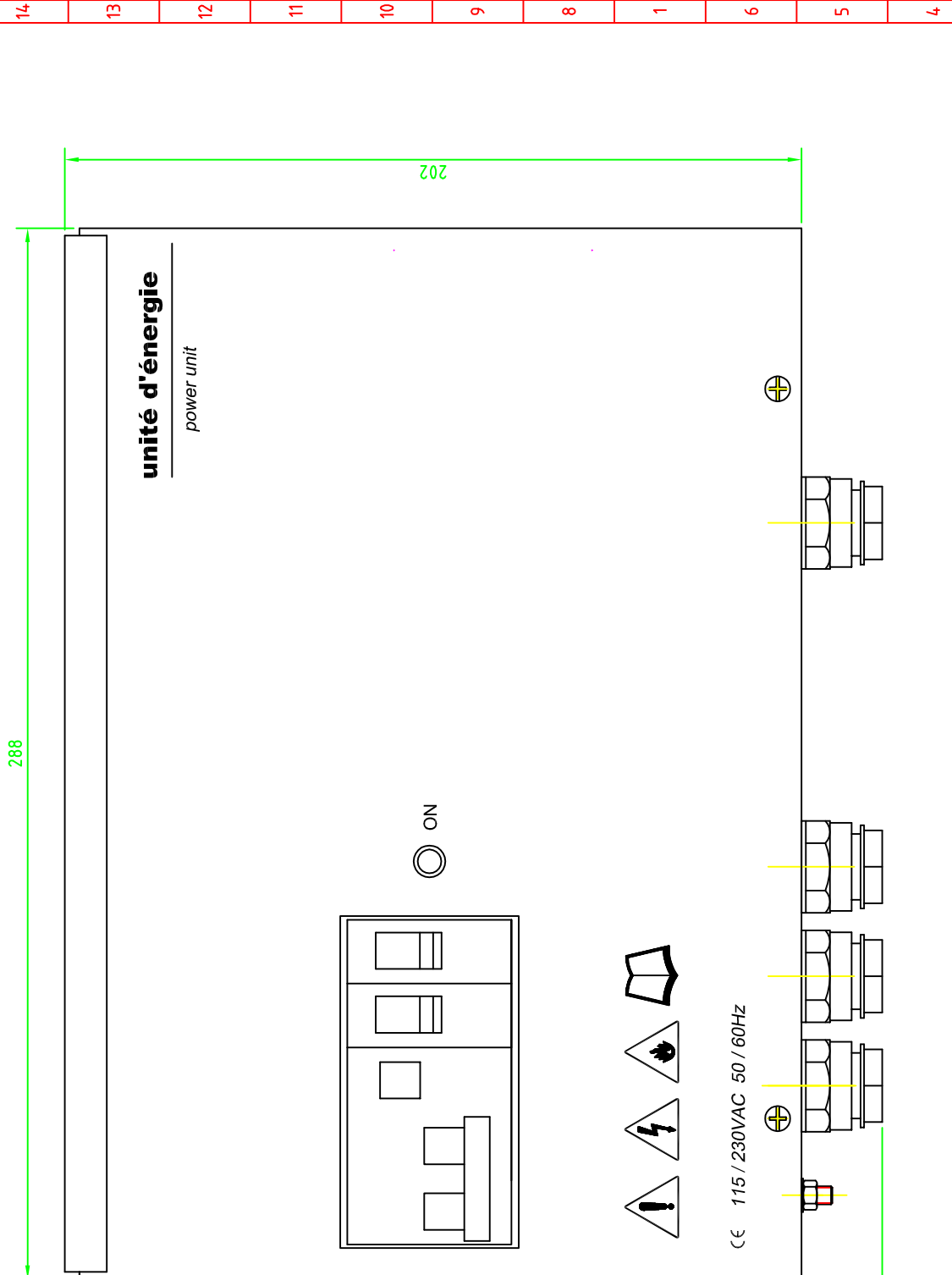

		Quantité :	
		Matière :	
		Visa	
Date	Indice	Modification	
UNITE 12V -10A		Ech : 0.8	Finition :
ENCOMBREMENT		Tol. générale :	Usiné :
47, Av. P. Mendès France		Dessiné : GLM	Le : 18 05 01
29000 QUIMPER		Vérifié :	F° : /
Tél. 02 98 53 80 82		N° 0668807 A	
Fax 02 98 55 64 94			



47, Av. P. Mendès France
29000 QUIMPER
Tél. 02 98 53 80 82
Fax 02 98 55 64 94

T S R Q P O N M L K J I H G F E D C B A

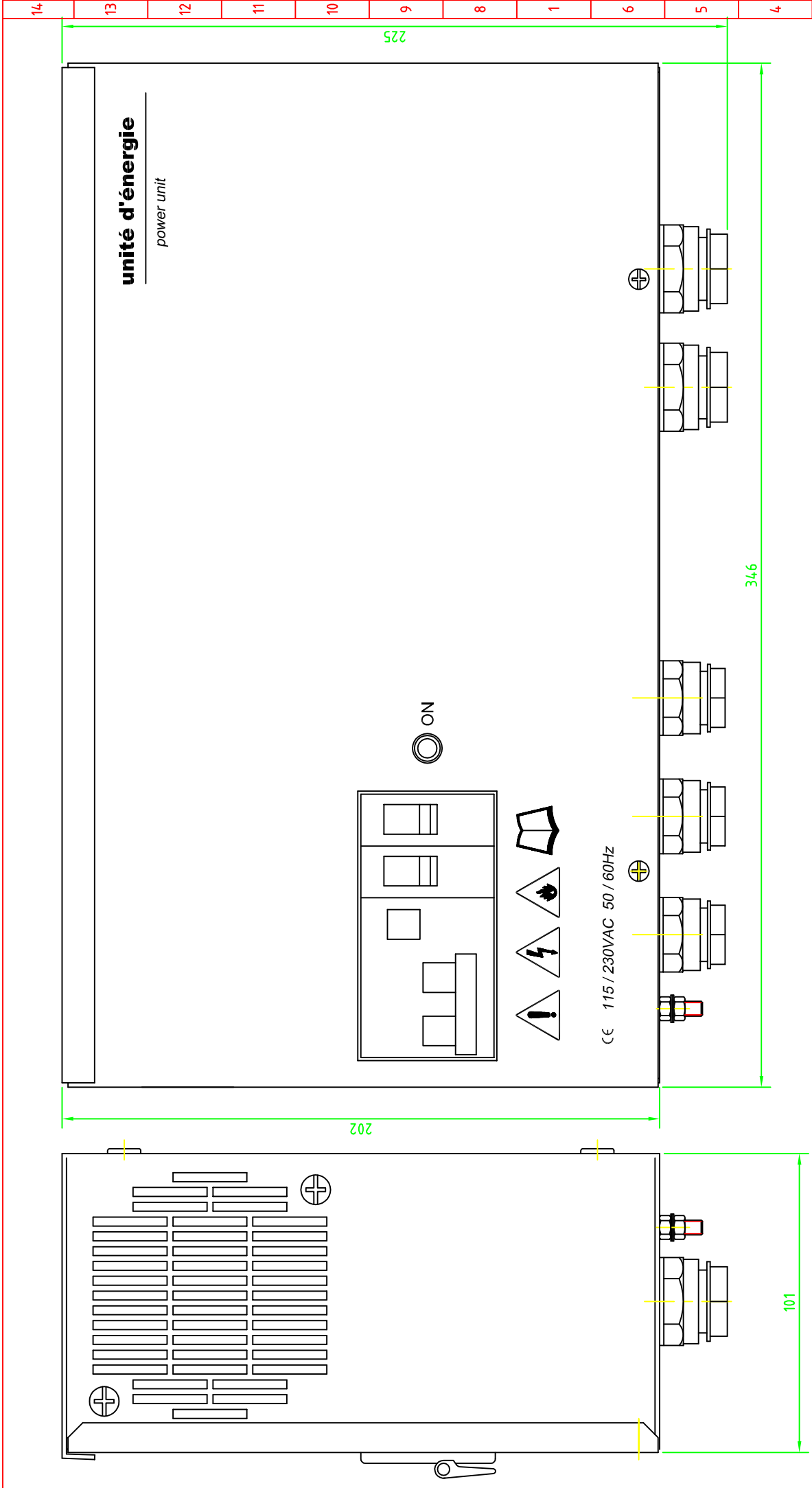

Date	Indice	Modification	Quantité :
			Matériau :
UNITE 12V - 16A			Ech : 0.8
ENCOMBREMENT			Finition :
47, Av. P. Mendès France			Tol. générale :
29000 QUIMPER			Dessiné : GLM
Tél. 02 98 53 80 82			Le : 25 09 01
Fax 02 98 55 64 94			Vérifié : /
			N° 06689 07A



T S R Q P O N M L K J I H G F E D C B A

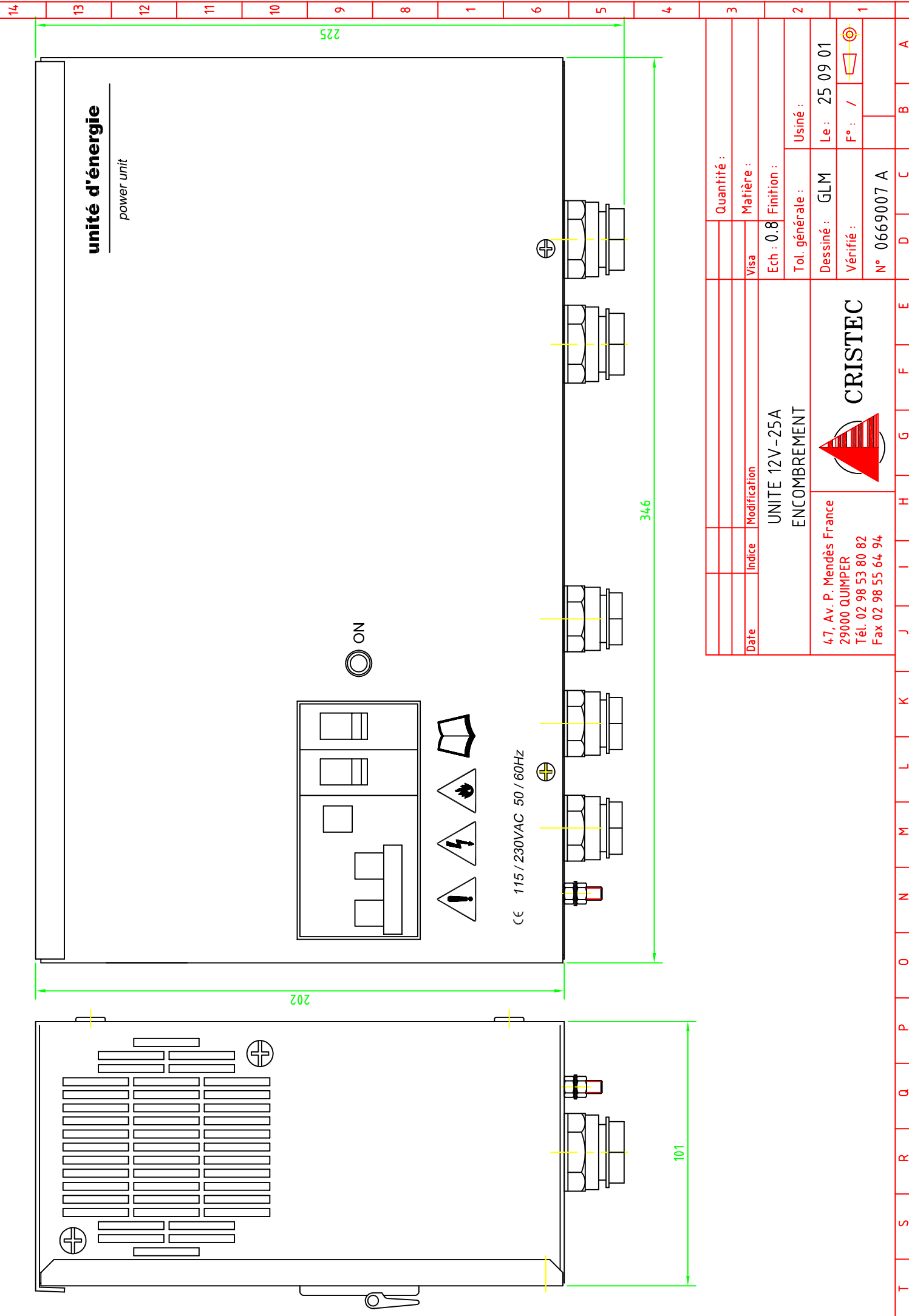

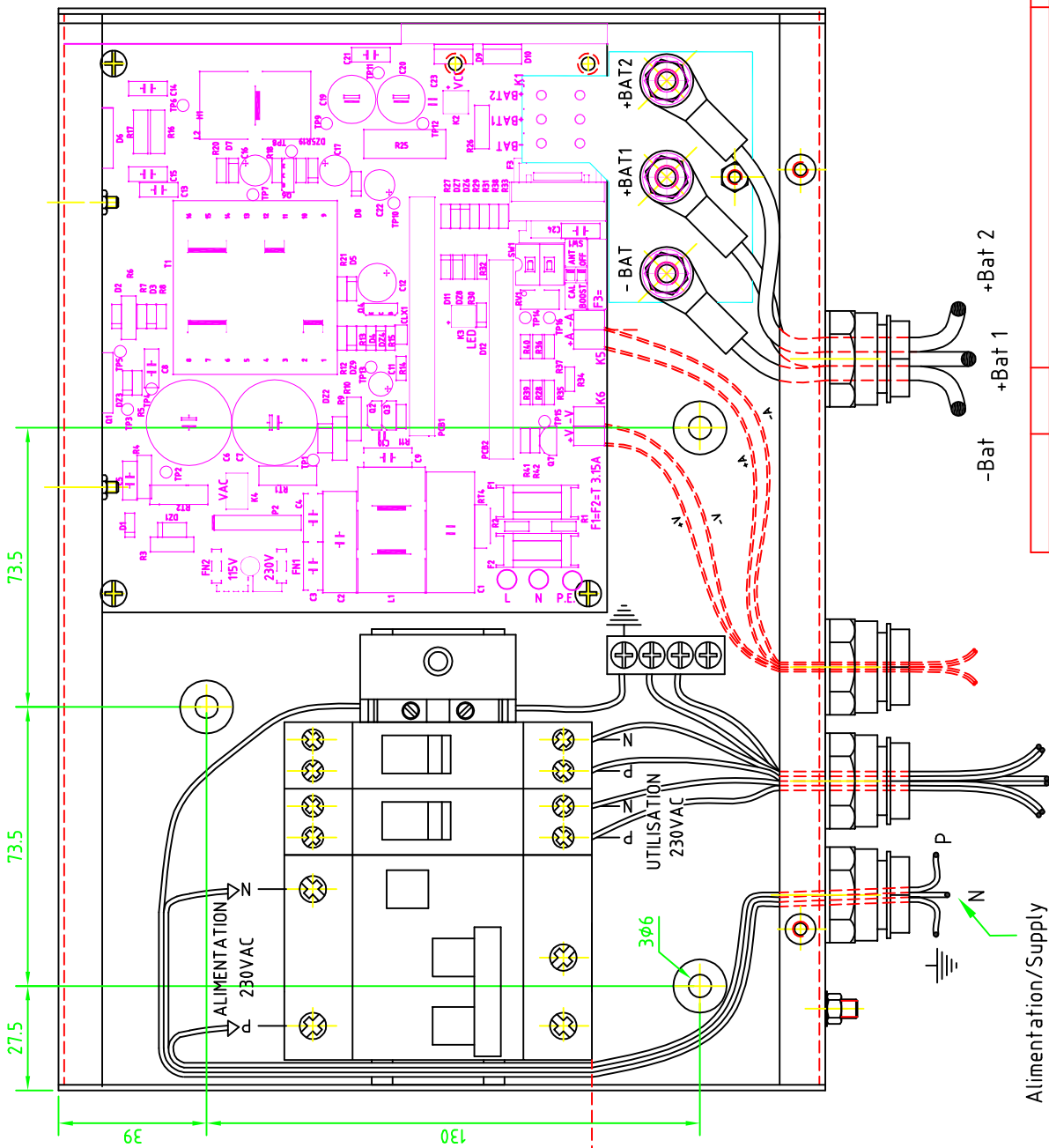

14
13
12
11
10
9
8
1
6
5
4
3
2
1

Quantité :	
Matériau :	
Visa	
Ech : 0.8	Finition :
Tol. générale :	Usiné :
Dessiné : D.V	Le : 25 09 01
Vérifié :	F° : /
N° 0668808 A	

UNITE 12V - 10A
FIXATION - CONNEXION



47, Av. P. Mendès France
29000 QUIMPER
Tél. 02 98 53 80 82
Fax 02 98 55 64 94

T S R Q P O N M L K J I H G F E D C B A

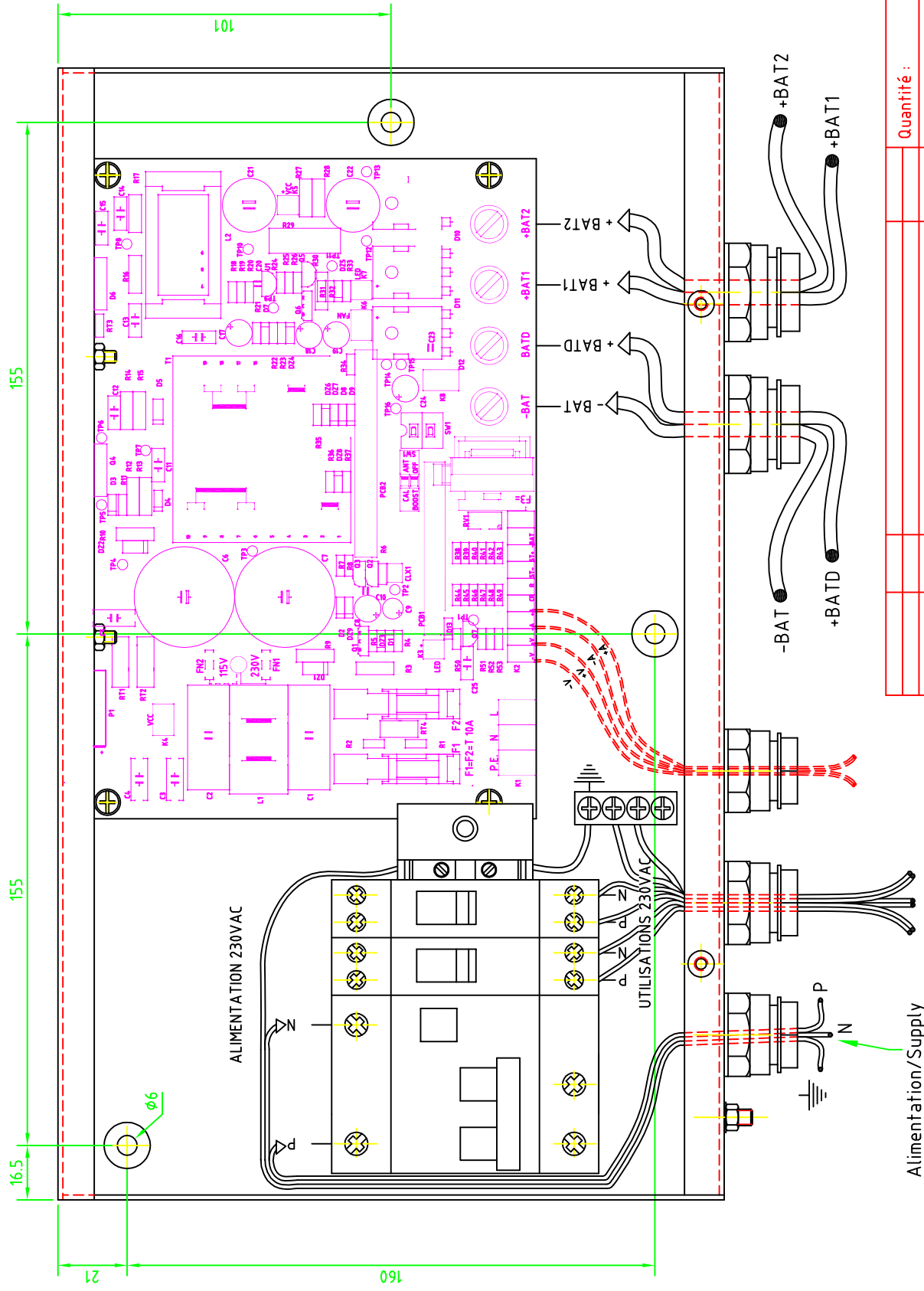

Date	Index	Modification	Visa	Quantité :
				Matière :
Ech : 0.8 Finition :				Usiné :
Tol. générale :				Le : 25 09 01
Dessiné : D.V				Vérifié :
N° 0668908A				

UNITE 12V -16A
FIXATION - CONNECTION



47, Av. P. Mendès France
29000 QUIMPER
Tél. 02 98 53 80 82
Fax 02 98 55 64 94

Alimentation/Supply
230 VAC
50Hz

Utilisation/Output
230 VAC
50Hz

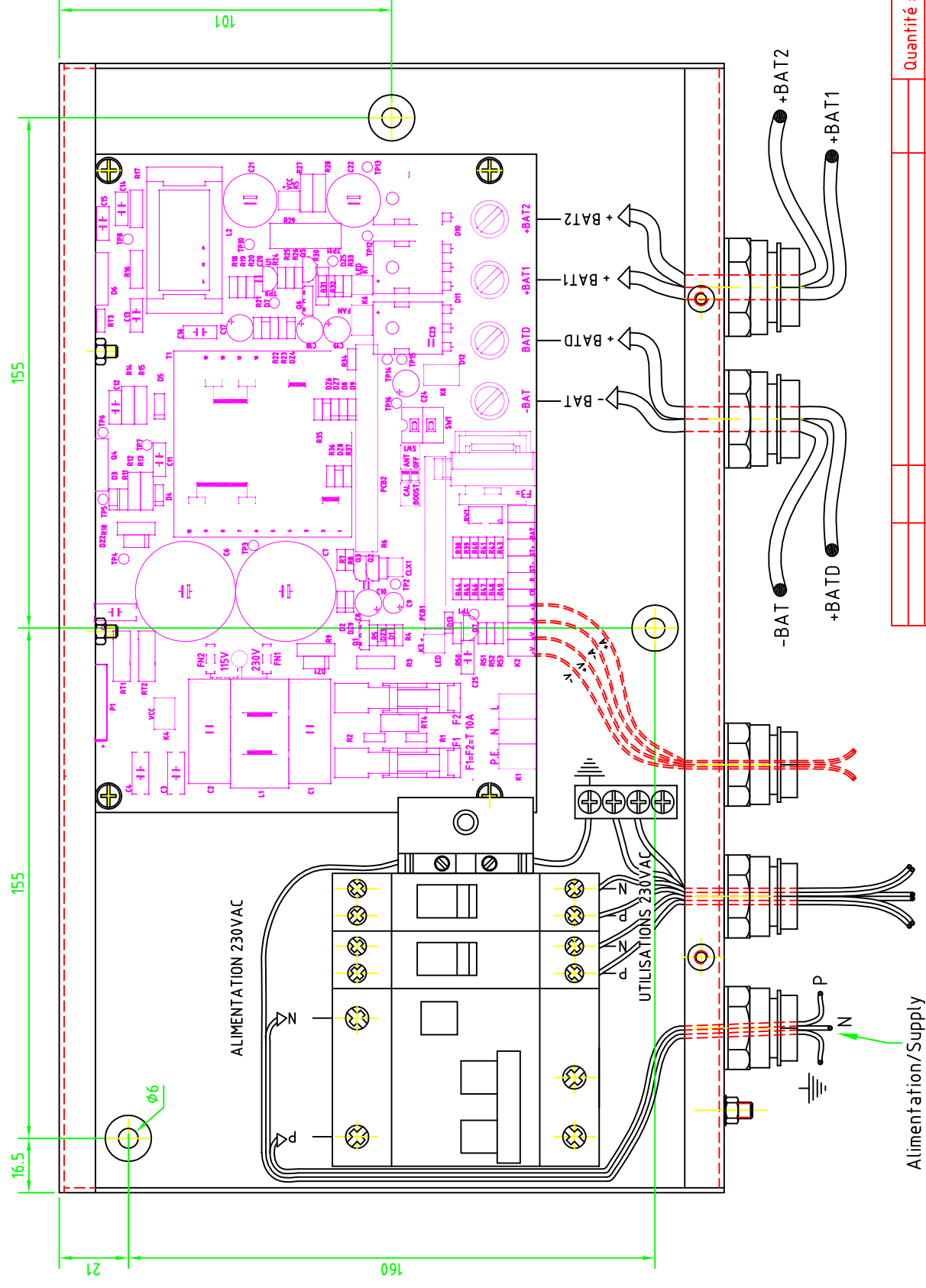

Alimentation/Supply
230 VAC
50Hz

Utilisation/Output
230 VAC
50Hz

UNITE 12V-25A
FIXATION

47, Av. P. Mendès France
29000 QUIMPER
Tél. 02 98 53 80 82
Fax 02 98 55 64 94



CRISTEC

Date	Index	Modification	Visa	Matière	Quantité
Ech : 0.8			Finition :		
Tol. générale :			Usiné :		
Dessiné : D.V			Le : 25 09 01		
Vérifié :			F° : /		
N° 0669008 A					

Selection de la tension réseau
Main voltage selection

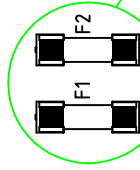
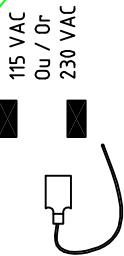

Line / Phase — L —
Neutral / Neutre — N —
Ground / Terre — PE —

R111=RV1

Réglage de la tension de sortie
Output voltage adjustment

Sélection du mode de charge et du type de batterie
Selection of charging mode and battery type

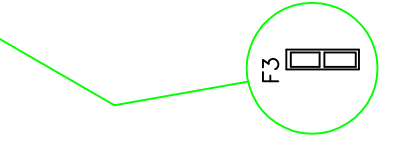
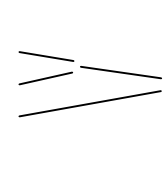
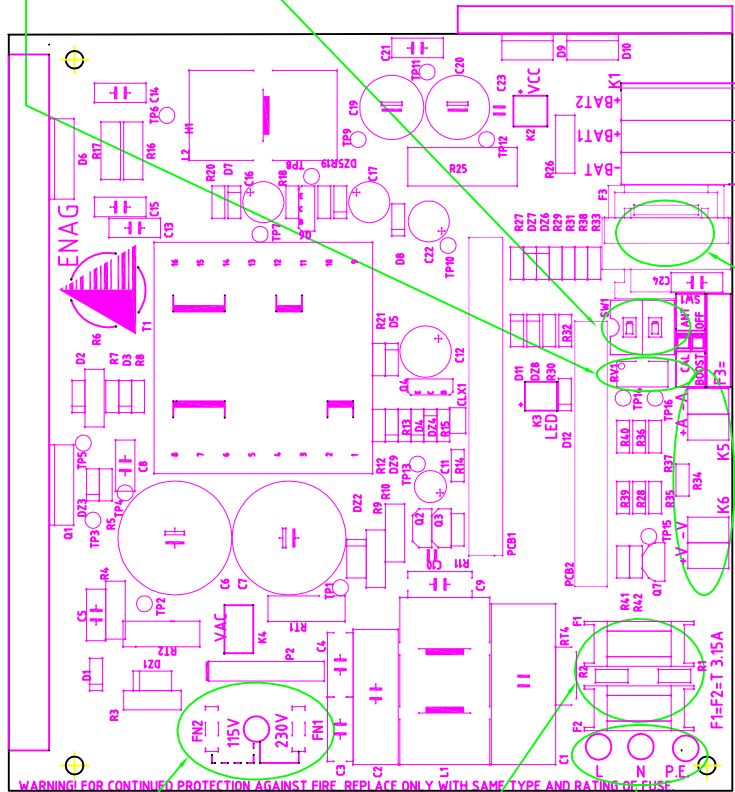
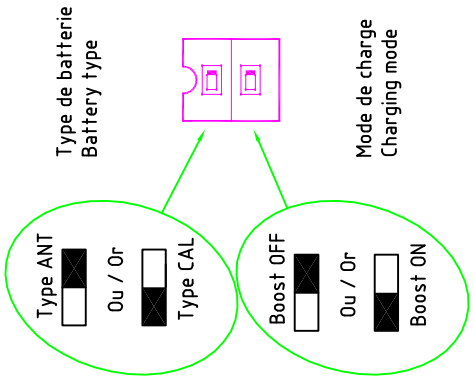

Output voltage Tension de sortie : (Boost OFF, Type ANT)	Bat 1 & 2 = 13,8VCC
Output fuse Fusible de sortie :	F3=15A TYPE 257015
Output current Courant de sortie :	10A

Input voltage Tension d'alimentation : Monophasé / Single phase	230VAC 4,7-63Hz	115VAC 4,7-63Hz
Input fuse Fusible d'entrée :	F1=F2=3,15A-250V TYPE 5x20	F1=F2=3,15A-250V TYPE 5x20
Input current Courant d'entrée :	1,5A	3A

Date	Indice	Modification	Quantité:
			Matière :
CPS120 115/230 - 50 - 12 - 10 - 2S			Ech : 1/1
CONNEXION & ADJUSTMENT			Tol. générale :
4,7, Av. P. Mendès France 29000 QUIMPER Tél. 02 98 53 80 82 Fax 02 98 55 64 94			Dessiné : P.C.
			Le : 15-06-2000
			Vérifié : F° /
			N° 05381 04
			A
			B
			C
			D
			E
			F
			G
			H
			I
			J
			K
			L
			M
			N
			O
			P
			Q
			R
			S
			T

Selection de la tension réseau
Main voltage selection

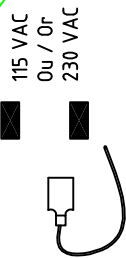

R111=RV1
Réglage de la tension de sortie
Output voltage adjustment

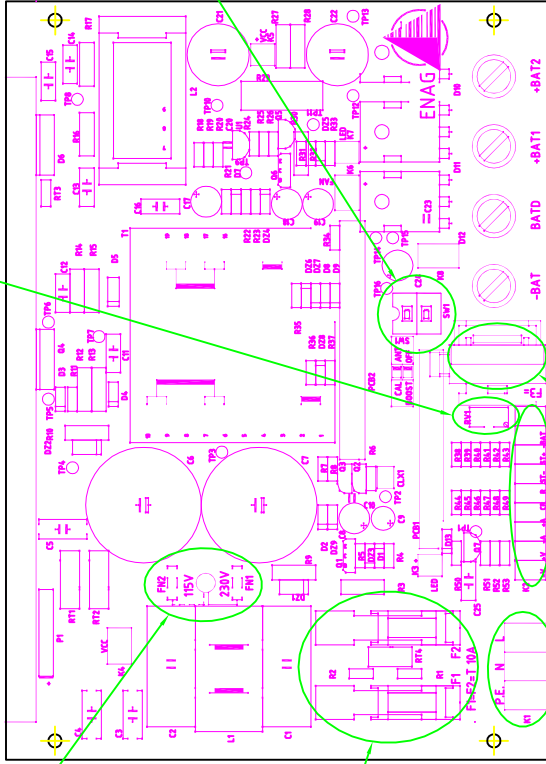

Sélection du mode de charge et du type de batterie
Selection of charging mode and battery type

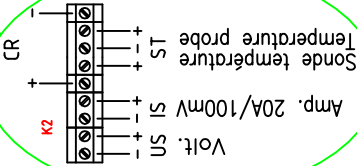
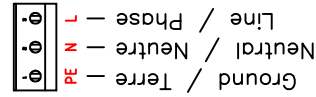
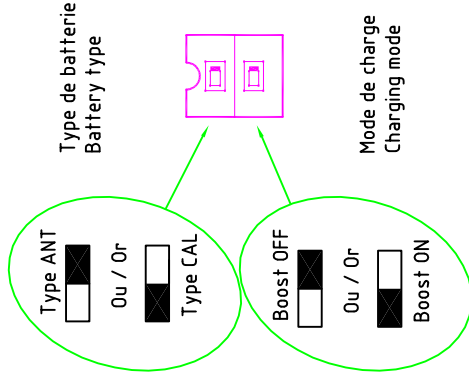

OUTPUT / SORTIE

Output voltage Tension de sortie : (Boost OFF, Type ANT)	Bat D = 13,4VCC Bat 1 & 2 = 13,8VCC
Output fuse Fusible de sortie :	F3=20A TYPE 257020
Output current Courant de sortie :	16A

Input voltage Tension d'alimentation : Monophasé / Single phase	230VAC 47-63Hz	115VAC 47-63Hz
Input fuse Fusible d'entrée :	F1=F2=10A-250V TYPE 326010	F1=F2=10A-250V TYPE 326010
Input current Courant d'entrée :	2A	4A

Date	Index	Modification	Quantité :
			Matière :
			Finition :
CPS190 115/230 - 50 - 12 - 16 - 3S			Ech : 3/4
CONNEXION & ADJUSTMENT			Tol. générale :
4,7, Av. P. Mendès France 29000 QUIMPER Tél. 02 98 53 80 82 Fax 02 98 55 64 94			Dessiné : P.C. Usiné : Le: 28-06-2000
			Vérifié : F° : /
			N° 05383 03 A
			D
			C
			B
			A

Selection de la tension réseau
Main voltage selection

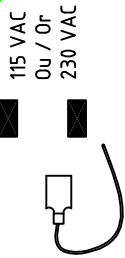

R111=RV1

Réglage de la tension de sortie
Output voltage adjustment

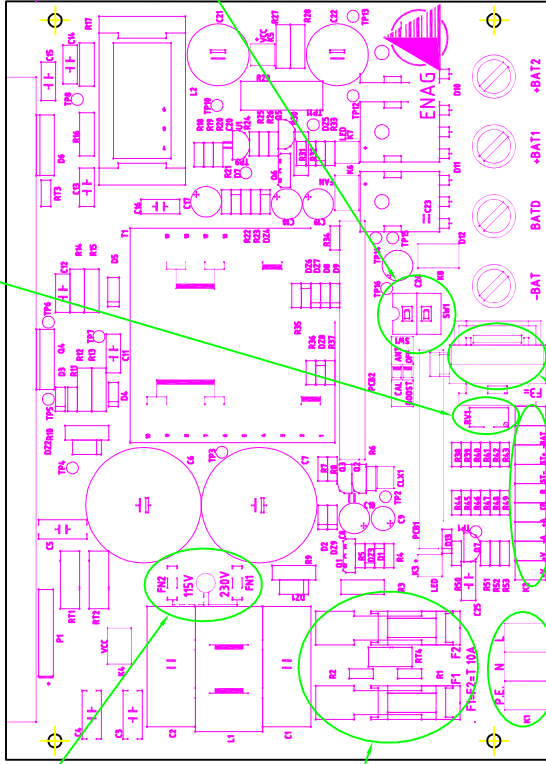

Sélection du mode de charge et du type de batterie
Selection of charging mode and battery type

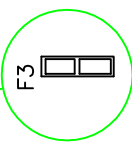
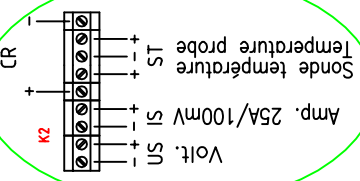
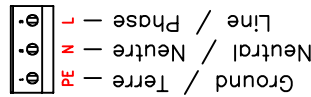
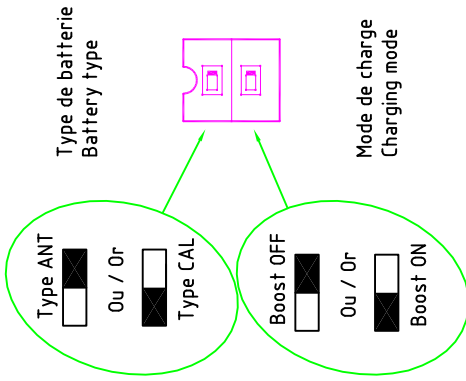

OUTPUT / SORTIE

Output voltage Tension de sortie : (Boost OFF, Type ANT)	Bat D = 13,4VCC Bat 1 & 2 = 13,8VCC
Output fuse Fusible de sortie :	F3=25A TYPE 257025
Output current Courant de sortie :	25A

Input voltage Tension d'alimentation : Monophasé / Single phase	230VAC 47-63Hz	115VAC 47-63Hz
Input fuse Fusible d'entrée :	F1=F2=10A-250V TYPE 326010	F1=F2=10A-250V TYPE 326010
Input current Courant d'entrée :	3,3A	6A

Date	Index	Modification	Quantité :
		Visa	Matière :
CPS300 115/230 - 50 - 12 - 25 - 3S			Ech : 3/4
CONNEXION & ADJUSTMENT			Tol. générale :
4,7, Av. P. Mendès France 29000 QUIMPER Tél. 02 98 53 80 82 Fax 02 98 55 64 94			Dessiné : P.C. Usiné : Le: 28-06-2000
			Vérifié : F° : /
			N° 05386 03 A



⑥ Notes





(à conserver précieusement)

(to be kept)

Référence de l'appareil (Model) : _____

Date d'achat (Purchase date) : _____

N° de série (Serial number) : _____

La garantie dont cet appareil fait l'objet traduit notre confiance dans la qualité des matériels et des hommes qui l'ont constitué. La garantie CRISTEC Industries protège votre investissement : lisez-la soigneusement.

Pendant trois ans à compter de la date d'acquisition, CRISTEC Industries remplacera sans frais de main-d'œuvre, toute pièce reconnue défectueuse, à son usine ou chez un de ses distributeurs agréés.

Pour que la garantie prenne effet, la carte de garantie doit être retournée remplie et convenablement affranchie à CRISTEC, dans les 30 jours qui suivent la date de l'achat.

The warranty on the product reflects the confidence of its maker in the quality of materials and workmanship that go into it. The CRISTEC Industries warranty has been established to protect your investment. Please read it carefully.

Within three year period from the original purchase, CRISTEC Industries will replace, without charge for labor or material, any part or parts in this equipment found to be defective in material or workmanship upon examination at its factory or any authorized dealers or warranty stations.

Warranty conditions :

The warranty takes effect only if the warranty registration card has been fully and properly completed and returned to CRISTEC Industries within the 30 days after the purchase date.



CARTE DE GARANTIE (WARRANTY CARD)

Référence de l'appareil (Model) : _____

Date d'achat (Purchase date) : _____

N° de série (Serial number.) : _____

Nom (Names) : _____

Adresse (Address) : _____

Rue (Street.) : _____

Ville (City) : _____

Code postal (ZIP code.) : _____

Pays (Country) : _____



CRISTEC

L'énergie embarquée

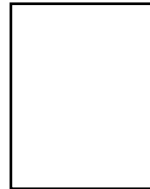

S.A.S CRISTEC

31, rue Marcel Paul - Z.I. Kerdroniou Est

29000 QUIMPER

FRANCE